

## Table of contents

Introduction	2
Instrumentation	3
Controls and features	9
Charging	13
Starting	22
Driving	25
Roadside emergencies	31
Maintenance and care	45
Capacities and specifications	55
Accessories	57
Index	62

All rights reserved. Reproduction by any means, electronic or mechanical including photocopying, recording or by any information storage and retrieval system or translation in whole or part is not permitted without written authorization from Ford Motor Company.

Copyright © 1999 Ford Motor Company

# Introduction

## WELCOME TO THE RANGER ELECTRIC VEHICLE

The 1999 Ranger Electric Vehicle is very similar to the gas-powered Ranger in appearance, interior and controls. The Ranger Electric Vehicle was built to be transparent from the gas-powered Ranger. There are enough differences that you should read this manual. Operation is the same, but some functions are different. The regular Ranger owner's manual covers common systems. This **Owner's Guide Supplement** contains the information specific to the Ranger Electric Vehicle.

## ICONS

The warning icon. Read the following section on *Warnings* for a full explanation.

## WARNINGS

Provide information which may reduce the risk of personal injury or prevent possible damage to others, your vehicle and its equipment.

## INFORMATION ABOUT THIS GUIDE

The information found in this guide was in effect at the time of printing. Ford may change the contents without notice and without incurring obligation.

## WARNING LIGHTS AND CHIMES

### Service indicator lamp

The service indicator lamp indicates that a vehicle malfunction has occurred. The vehicle should be returned to an authorized Ford Electric Vehicle (EV) Dealer for service.



### Brake warning lamp

The brake warning lamp illuminates when there is a regenerative braking system malfunction, low fluid level in the master cylinder or low fluid pressure in the hydraulic lines, or when the parking brake is engaged. If the lamp remains illuminated after the parking brake is fully released and the master cylinder is full, the vehicle should be taken to an authorized Ford EV Dealer.



### Charging lamp

The charging lamp illuminates when the key is turned to the ON or START position while the vehicle is connected to the power control station (PCS). If the lamp flashes when the key is in the ON position, there is a vehicle malfunction and the drive battery cannot be charged. Confirm the vehicle is in park and the PCS cord is properly attached. If the vehicle is in P (Park) and the PCS cord is properly connected and the charging lamp continues to flash, then the vehicle should be taken to an authorized Ford EV Dealer.



### Low oil pressure lamp

The low oil pressure lamp indicates that the transaxle oil lubrication system is operating below the desired pressure. Oil cannot be added by the owner. The vehicle should be returned to an authorized Ford EV Dealer as soon as possible. Driving in excess of 50 miles to reach an authorized dealer may damage the transaxle.

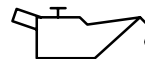

## Instrumentation

### Electrical hazard warning lamp

The electrical hazard warning lamp indicates a malfunction in the high-voltage system. The vehicle will not charge and must be returned to an authorized Ford EV Dealer immediately.



### Auxiliary battery lamp

The auxiliary battery lamp indicates there is an auxiliary battery charging malfunction. Return the vehicle to an authorized Ford EV Dealer immediately.

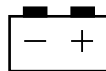

### Low fuel lamp

The low fuel lamp indicates that the vehicle's drive battery has reached a 10% state of charge. The vehicle must be placed on charge. The indicator will flash when the battery reaches a 0% state of charge.



### Power limit lamp

The power limit lamp indicates a system fault or reduced vehicle performance to conserve remaining drive battery power. As the vehicle nears complete discharge, the power limit lamp will illuminate. High-voltage accessories (A/C and heat) will be disabled. You will notice a decrease in vehicle performance and you must return to a PCS (power control station) immediately. The lamp will begin to flash and the performance of the vehicle will be severely limited. The vehicle will continue to operate until the drive battery is completely drained; however, driving under this condition will damage the battery, resulting in reduced battery life.

**POWER  
LIMIT**

### Anti-lock brake system (ABS) lamp

The ABS lamp indicates that there is a malfunction with the ABS. If the light stays on or continues to flash after the vehicle is started, return the vehicle to an authorized Ford EV Dealer for service.



### Econ mode lamp

The econ mode lamp indicates that the gearshift is in the E (Economy) position. This mode is recommended for urban traffic and will improve range by increasing the effects of regenerative braking and limiting top speed to 105 km/h (65 mph). The D (Drive) position is recommended for highway operation at steady speeds.

**ECON  
MODE**

### Power reset lamp

The power reset lamp indicates that the inertia shutoff switch has been tripped and all high-voltage power has been disconnected and power has been limited to the traction battery. If there is no damage to the vehicle, reset the switch to reactivate the high-voltage power systems.

**POWER  
RESET**

## Instrumentation

The inertia shutoff switch is located by the passenger kick panel. If there is damage to the vehicle, have the vehicle towed to an authorized Ford EV Dealer.

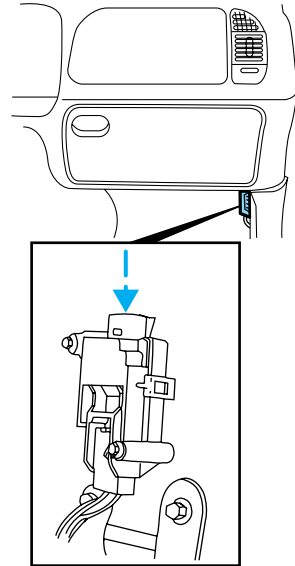

### RANGER EV FOR MEXICO AND CANADA

The instrument cluster on the Ranger EV for Mexico and Canada will be equipped with metric gauges. All gauges operate as described below.

#### GAUGES

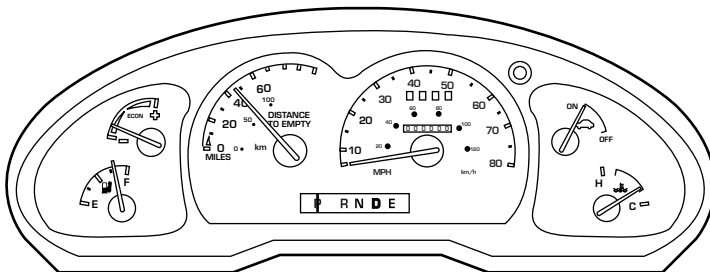

## Battery state of charge gauge

The battery state of charge gauge is the equivalent of a fuel gauge on a gasoline-powered vehicle. F (Full) indicates that the battery is completely charged. E (Empty) indicates the battery has been discharged to the point where additional operation will damage vehicle systems.

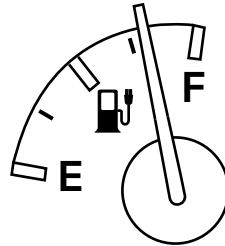

## Economy gauge

The economy gauge provides information about the vehicle's energy usage. Economical usage of the vehicle is indicated by the gauge reading near the plus (+) side and will maximize the vehicle's range.

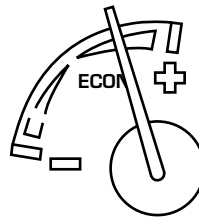

## Distance to empty gauge

The distance to empty gauge estimates the remaining distance the vehicle can travel before requiring a drive battery recharge. The gauge reading is based on remaining drive battery energy, driving conditions and recent vehicle usage.

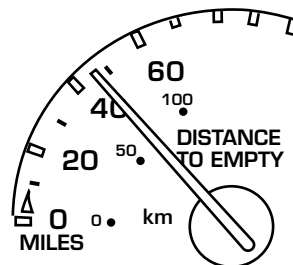

## Instrumentation

### Motor enabled gauge

The motor enabled gauge indicates that the vehicle is ready to drive. Turning the ignition switch to the full START position and releasing will turn the vehicle on, and the gauge will move to the ON position.

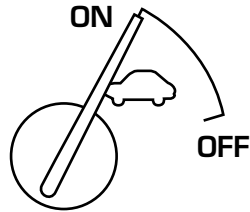

### Temperature gauge

The temperature gauge indicates the temperature of the vehicle's components. Unlike conventional temperature gauges, it does not start cold and move to normal. The gauge sits at normal and moves to hot or cold when there is a problem. If the gauge moves to H (Hot), vehicle performance will be limited until the coolant temperature or drive battery temperature returns to normal. The vehicle should be stopped and plugged into a PCS until it has cooled down. The vehicle may need servicing. If the gauge moves to C (Cold), the vehicle may have an extended charge time and a reduced driving range.

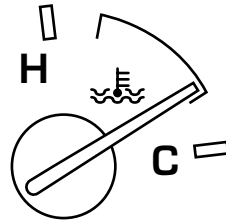



## Controls and features

### CLIMATE CONTROL SYSTEM

Your vehicle is equipped with an automatic temperature control (ATC) system designed to maintain a selected temperature with a combination A/C-Heater system.

#### Air conditioning (A/C) and heater controls

The control for your air conditioning and heater system is located at the center of the instrument panel below the radio and will operate in the KEY-ON position. Your air conditioner and heater will heat and/or cool your vehicle interior depending on the function position and temperature you select. The mode selector knob allows you to select heating or cooling, and determine where the air will be directed. The temperature control knob setting determines the desired interior temperature of the vehicle. To turn your air conditioner or heater system on, select any position except OFF. This will turn the fan on and allows air flow into the vehicle. To turn your air conditioner or heater system off, select OFF. This will turn the fan off and stop airflow from coming into the vehicle.

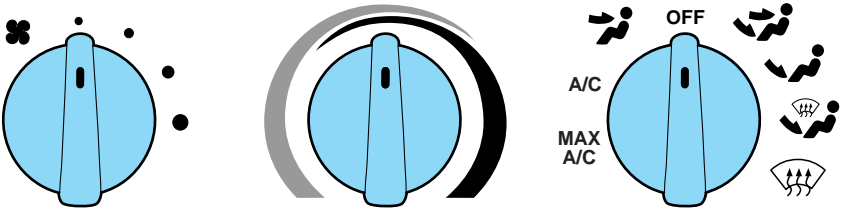





#### Recirculation switch

The recirculation switch is located at the center of the instrument panel just right of the radio. It allows switching from outside air to recirculated air in Panel, Panel/Floor, and Floor modes. The recirculation switch operates for five minutes, then shuts off. If more recirculation operation is desired, press the control again. Note that in MAX A/C and A/C modes, the function is automatic (stays in recirculation mode) and cannot be switched off. A table of recirculation switch operation follows.



## Controls and features

Recirculation Switch Operation		
Icon	Mode	Recirculation
MAX A/C	Max A/C	Automatic
A/C	A/C	Automatic
	Panel	Selectable
OFF	OFF	Not Available
	Panel/Floor	Selectable
	Floor	Selectable
	Floor/Defrost	Not Available
	Defrost	Not Available

### Fan speed knob

The left knob on the control is the fan control knob, which controls the volume of air flow. Rotate the knob to the right to increase fan speed and increase the amount of air entering the vehicle. Four fan speed positions are available and are indicated by dots beside the control knob. The largest dot is the high-speed position.

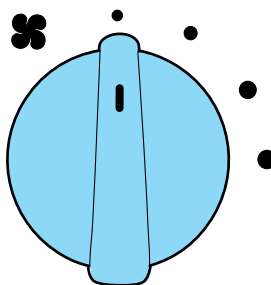

### Temperature control knob

The temperature control knob is the rotating knob located at the center of the control with tapered red and blue bands surrounding most of the knob. The wide red part of the band (full right) is the warm temperature area. The wide blue part of the band (full left) is the cool temperature area. Any position selected between full right and full left will give a temperature between maximum heating 29°C (84°F) and maximum cooling 18°C (64°F) (A/C and MAX A/C modes only).

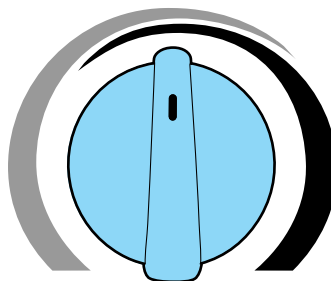



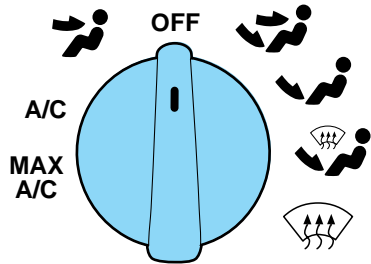

## Controls and features

### Mode selector knob

The right knob on the control is the mode selector, which controls the direction of the airflow inside the vehicle.



- MAX A/C-Select to distribute recirculated air through the instrument panel registers. This position produces cool air more rapidly to provide faster cooling of your vehicle. Using MAX A/C may be noisier and less economical than A/C.
- A/C-Select to distribute cool recirculated air through the instrument panel registers. This position should be used for cooling except when it is extremely hot or fast cooling of the vehicle is needed.
-  (panel)-Select to distribute outside air or recirculated air through the instrument panel registers. The air may be heated based on temperature selection. The air cannot be cooled below the outside temperature regardless of the temperature setting.
-  (panel and floor)-Select to distribute outside air or recirculated air through the instrument panel registers and to the floor ducts at the same time. The air may be heated based on temperature selection. The air cannot be cooled below the outside temperature regardless of the temperature setting.
-  (floor)-Select to distribute outside air or recirculated air through the floor ducts. The air may be heated based on temperature selection. The air cannot be cooled below the outside temperature regardless of the temperature setting.
-  (floor and defrost)-Select to distribute outside air through the floor ducts and the windshield defroster ducts at the same time. If the outside air temperature is 10°C (50°F) or warmer, the air conditioner will dehumidify the air to prevent fogging. The air may be heated and/or cooled based on temperature selection.

## Controls and features

-  (defrost)-Select to distribute outside air through the windshield defroster ducts. Defrost can be used to clear ice or fog from the windshield. If the outside air temperature is 10°C (50°F) or warmer the air conditioner will dehumidify the air to prevent fogging. The air may be heated and/or cooled based on temperature selection.

### ***Operating tips***

- In humid weather, select defrost before driving. This prevents your windshield from fogging. After a few minutes of operation, you may select another function.
- Remove any snow, ice or leaves from the air intake area of your heater system that could block the air intake. The intake area is located at the bottom of the windshield.
- If temperatures below -18°C (0°F), select recirculation before driving. This will help warm the vehicle interior and minimize degraded performance at low outside temperatures.
- The use of climate controls will reduce the vehicle's range. Limit the use of maximum heating and cooling of the vehicle interior.

### CHARGING

Charging the Ford Ranger Electric Vehicle is a safe, simple process.

**In-garage charging of the Ranger Electric Vehicle has received UL approval.** To maximize range, the vehicle should be connected to a power control station (PCS) whenever possible to keep the battery fully charged.

A conductive power control station (PCS) is required to recharge your Ranger Electric Vehicle. The PCS consists of a “smart” box and a connector and cable assembly that safely conducts AC power from the utility supply grid to the vehicle inlet (located at the right front of the vehicle, next to the right headlamp). An important feature of the PCS is an integrated control pilot circuit, which performs safety functions such as verifying the vehicle is present and safely connected, start/stop control, confirming the smart box is ready to send power, confirming the vehicle is ready to accept power, and continuously verifying the presence of an equipment ground. The PCS supplies the power commanded **by the vehicle.**

These stations will be in private locations (for example, residential or fleet garages) or in public sites (for example, shopping malls, restaurants, parking lots and so on). The PCS uses a 40 amp, 240 volt, AC electrical supply.

The customer is responsible for ordering the PCS and getting it installed. Your Ford Dealer will provide information on how to purchase and how to get your PCS installed.

Consult your PCS owner’s manual for specific instruction on using your PCS. Additional installations or service requirements that you might need should be performed by a full service installer. Contact your Ford dealer for a complete listing. If your installer finds any PCS malfunctions, contact the PCS manufacturer.



Always follow charging instructions carefully. Failure to do so may result in vehicle damage, personal injury or death.

### To connect the PCS:



Always set the parking brake fully. Make sure the gearshift lever is placed in P (Park) position. Turn off the “ignition” whenever you leave your vehicle.

## Charging

1. Park the Ranger Electric Vehicle. The vehicle's charge inlet is at the right front of the vehicle in the grille, next to the right headlamp.
2. Place the gearshift lever in P (Park) and set the parking brake.



3. Turn the "ignition" to LOCK and remove the key from the "ignition."
4. Open the charge inlet access door in the front grille. The door is hinged toward the right headlamp and opens in the same manner as the fuel filler door.

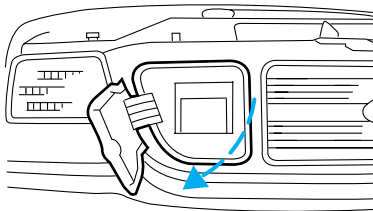

5. Pick up the PCS connector and position it so that the release button is facing upwards.

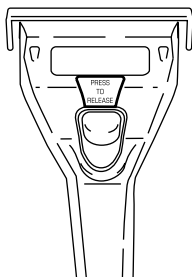

6. Align the PCS connector to the charge inlet, fully insert the connector and make sure that the tabs on both sides of the connector engage the slots in the inlet.

7. Gently push the connector down, toward the bumper, until you hear a click. The click means that the connector is locked into the inlet.

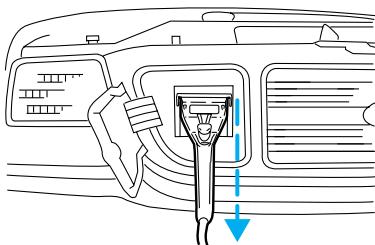

8. The time required to charge the vehicle depends on the battery temperature and the state of charge when the vehicle is plugged in. The normal charge time is 6–8 hours. Reduced supply voltage, from the recommended 240 volts, may adversely affect the normal charge time.

### ***Estimated charge time***

The amount of time required to fully charge the battery pack varies depending upon the beginning state of charge and battery temperature. Note that battery temperature is not necessarily the same as outside temperature. The use of outside temperature to plan charge times, however, is the most straightforward approach.

Typically it will take 6–8 hours for the vehicle to fully charge from “empty” to “full.” Use the battery state of charge gauge as a guide to assess whether enough charge time was allowed. If the gauge does not indicate “full” when the “ignition” is moved to the ON position, one of the following may have happened:

- The battery pack may be too warm or too cold. Charge times can increase to 10 hours or more for warmer or cooler batteries. In severe temperature conditions (battery temperature less than 5°C [41°F], or greater than 60°C [140°F] for the lead-acid type and less than –25°C [–13°F] or greater than 45°C [113°F] for the nickel metal hydride type) the vehicle will not charge at all.
- The PCS may be malfunctioning.
- The battery pack may be out of electrical balance. The vehicle will perform a balancing charge, which may take up to four hours for the lead-acid type or two hours for the nickel metal hydride type over the normal charging time, and then indicate “full.”
- The gearshift lever was not in P (Park).
- The battery pack (lead-acid type only) may be new. Vehicles that have experienced less than 10 drive/charge cycles need an additional few hours of charge time.

Refer to charging troubleshooting later in this section.

If none of the above apply, the vehicle should be returned to the PCS to attempt to complete charging or taken to an authorized Ford EV Dealer.

### **Lead-acid traction battery**

At 25°C (77°F), the drive battery can be charged to 80% capacity in about three hours; 100% capacity requires approximately six to eight

## Charging

hours. Completely charging the drive battery is important to ensure maximum range and battery life. Ford recommended practice is that the vehicle should always be left on-plug when not in use and be allowed to fully charge before driving.

Charge time may increase at colder or hotter temperatures. The drive battery must be above 5°C (41°F) and below 60°C (140°F) before charging will begin. After being connected to a PCS, the vehicle will automatically heat or cool the drive battery, as needed. When the battery reaches the necessary temperature, charging will begin. Following a complete charge in colder climates, charging will continue at periodic intervals to maintain the battery at -10°C (14°F).

**The Ranger Electric Vehicle should be connected to a PCS whenever it is not being driven.**

If a PCS is not available, the vehicle may be stored off-plug for up to 28 days without suffering permanent damage as long as the initial state of charge is greater than 50%. The frequency of this type of storage should be limited to a few occurrences over the life of the vehicle.

### **Nickel metal hydride traction battery**

At 25°C (77°F), the drive battery can be charged to 80% capacity in about five to six hours; 100% capacity requires approximately six to eight hours. Completely charging the drive battery is important to ensure maximum range and battery life. Ford recommended practice is that the vehicle should always be left on-plug when not in use and be allowed to fully charge before driving.

Charge time may increase at colder or hotter temperatures. The drive battery must be above -25°C (-13°F) and below 45°C (113°F) before charging will begin. After being connected to a PCS, the vehicle will automatically cool the drive battery as needed. When the battery reaches the necessary temperature, charging will begin. Following a complete charge in colder climates, charging will continue at periodic intervals to maintain the battery at -10°C (14°F).

**The Ranger Electric Vehicle should be connected to a PCS whenever it is not being driven.**

If a PCS is not available, the vehicle may be stored off-plug for up to 28 days without suffering permanent damage as long as the initial state of charge is greater than 50%. The frequency of this type of storage should be limited to a few occurrences over the life of the vehicle.



## Charging

### To disconnect the PCS:

1. Push the STOP button on the PCS.
2. Grasp the charge connector and press the button in the center of the handle.

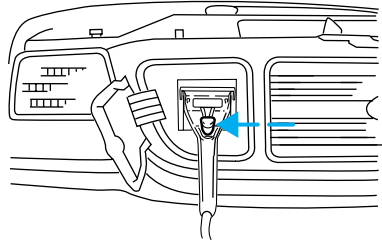

3. Pull the charge connector upward and pull it out of the inlet.

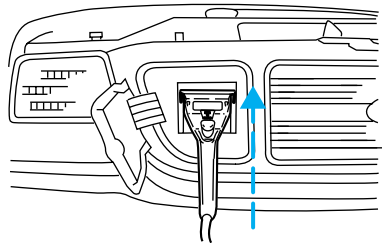

4. Close the charge inlet access door in the front grille.

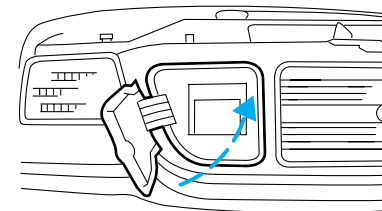

5. Return the connector and cable to their proper location.

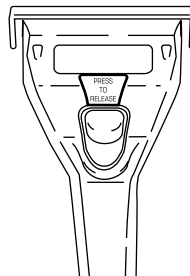

## Charging

### ***Charging troubleshooting using SCI systems (SCI®) equipment***

If your vehicle fails to charge, follow this procedure to determine if your Power Control Station (PCS) is operating properly:

1. Make note of any lights that are flashing or steadily illuminated on your PCS.
2. Determine if the charge connector is properly inserted in the vehicle inlet and locked in place.
3. Is the charge interrupt light illuminated? If yes, your vehicle may have undergone a series of faults which forced the PCS to terminate the charge process.
  - Push the stop button.
  - Unplug the connector from the vehicle inlet, to clear the fault.
  - Inspect the cable and connector for any signs of possible damage (i.e. cuts, tears or breaks in the cable insulation). If damage is found, stop any further attempts to charge the vehicle and call the PCS manufacturer for repair.
  - If the cable and connector are undamaged reconnect the PCS to the vehicle inlet. Is the charge interrupt light still illuminated or flashing? Consult your authorized Ranger EV dealer to determine possible vehicle fault.
4. Is the service light illuminated? If yes,
  - Disconnect the charge connector vehicle inlet.
  - Turn off the power to your PCS at the service or disconnect panel. Turning off the power may allow the PCS to clear the fault.
  - Turn the power back on and reconnect the PCS to the vehicle inlet. Is the service light still illuminated? If so, call the PCS manufacturer for repair or replacement. The toll free number is located on the PCS.

### ***Charging troubleshooting using Electric Vehicle Infrastructure (EVI®) equipment***

If your vehicle fails to charge follow this procedure to determine if your Power Control Station (PCS) is operating properly:

1. Make note of any lights that are illuminated or any messages being issued by your PCS.
2. Determine if the charge connector is properly inserted in the vehicle inlet and locked in place.

3. Is the protection light illuminated? If yes, your vehicle may have undergone a series of faults which forced the PCS to terminate the charge process.

- Push the stop button.
- Unplug the PCS charge connector from the vehicle inlet, to clear the fault.
- Inspect the charge cable and connector for any signs of possible damage (i.e. cuts, tears or breaks in the cable insulation). If damage is found, stop any further attempts to charge the vehicle and call the PCS manufacturer for repair.
- If the charge cable and connector are undamaged, reconnect the vehicle. Is the charge interrupt light illuminated or flashing? Consult your authorized Ranger EV dealer to determine possible fault.

4. Is the service light illuminated? If yes,

- Disconnect the PCS charge connector from the vehicle inlet.
- Turn off the power to your PCS at the service or disconnect panel. Turning off the power may allow the PCS to clear the fault.
- Turn the power back on and reconnect the PCS to the vehicle. Is the service light still illuminated? If so, call the PCS manufacturer for repair or replacement.
- Are the ready or charging lights illuminated? If yes, your PCS is operating correctly. Consult your authorized Ranger EV dealer to determine vehicle fault.
- If turning the PCS power on and off or unplugging and plugging the charge connector in the vehicle inlet does not cause any of the lights to illuminate on the PCS, the PCS has either failed or has a damaged charge cord. Call the PCS manufacturer for repair or replacement. The toll free number is located on the PCS.

**The Ranger Electric Vehicle should be connected to a PCS whenever it is not being driven.**

### **Battery pack heating/cooling system (lead-acid type)**

The battery pack assembly contains 39 eight-volt batteries, wiring, a fan for ventilation and cooling, a control system and optional heaters for cold weather climates. These components work automatically when the vehicle is on-plug charging, and are monitored by the battery pack control system. Heating and cooling do NOT occur key OFF and off-plug.

## Charging

The systems are designed to maintain battery pack temperatures when on-plug as well as during the drive cycle, and may not be able to heat or cool batteries that have reached excessive temperatures.

Battery temperatures tend to be warmer than outside temperature if driven and fully charged each day. If left off-plug, the batteries will eventually equalize to outside underbody temperature, although this process can take several days to occur. Extended periods off-plug in cold outdoor temperatures can cause the batteries to take several days to warm up.

The heaters maintain the battery pack at approximately 20° (68°F) and are effective to at least -20°C (-4°F). The cooling fan utilizes outside air, and therefore cooling effectiveness depends upon the temperature difference between the batteries and outside air. The cooling system works to maintain the batteries at approximately 35°C (95°F).

### Equalization

The battery control system will periodically equalize the charge in the batteries, which smooths out battery-to-battery differences in the ability to deliver energy. This results in optimum range and battery life. Equalization is automatically performed approximately every three weeks. The fuel gauge will indicate if insufficient charge time has been allowed.

**The Ranger Electric Vehicle should be connected to a PCS whenever it is not being driven.**

### Battery pack heating/cooling system (nickel metal hydride type)

The battery pack assembly contains 25 twelve-volt batteries, wiring, two fans for ventilation and cooling and a control system. Following a complete charge, battery heating is accomplished by periodically overcharging the batteries to maintain a minimum acceptable temperature. These components work automatically when the vehicle is on-plug charging, and are monitored by the battery pack control system. Heating and cooling do NOT occur key OFF and off-plug. The systems are designed to maintain battery pack temperatures when on-plug as well as during the drive cycle, and may not be able to heat or cool batteries that have reached excessive temperatures.

Battery temperatures tend to be warmer than outside temperature if driven and fully charged each day. If left off-plug, the batteries will eventually equalize to outside underbody temperature, although this process can take several days to occur. Extended periods off-plug in cold

outdoor temperatures can cause the batteries to cool to below  $-25^{\circ}\text{C}$  ( $-13^{\circ}\text{F}$ ) and prevent both charging and self-heating.

**The Ranger Electric Vehicle should be connected to a PCS whenever it is not being driven.**

Battery self-heating following a complete charge will maintain the battery at approximately  $-10^{\circ}\text{C}$  ( $14^{\circ}\text{F}$ ). The cooling fan utilizes outside air, and therefore cooling effectiveness depends upon the temperature difference between the batteries and outside air. The cooling system works to maintain the batteries at approximately  $25^{\circ}\text{C}$  ( $77^{\circ}\text{F}$ ).

### Equalization

The battery control system will periodically equalize the charge in the batteries, which smooths out battery-to-battery differences in the ability to deliver energy. This results in optimum range and battery life. Equalization is automatically performed approximately every three weeks. The fuel gauge will indicate if insufficient charge time has been allowed.

**The Ranger Electric Vehicle should be connected to a PCS whenever it is not being driven.**

### Partial recharges

A partial recharge is charging the battery pack to less than 100% state of charge and can be performed occasionally without loss of range or performance. However, long term multiple partial charges tend to create imbalances in battery-to-battery state of charge and are strongly discouraged. Usage patterns should be planned to include a full recharge each time the vehicle is discharged. On vehicles equipped with the nickel-metal hydride drive batteries, a full discharge is recommended periodically to minimize battery memory effect.

# Starting

## POSITIONS OF THE IGNITION SWITCH

1. ACCESSORY allows the accessories such as the radio to operate while the motor is not powered up.
2. LOCK locks the steering wheel gearshift lever. Allows key removal.
3. OFF disconnects all high-voltage power from the traction battery.
4. ON, warning lights momentarily illuminated. Key position when driving.
5. START powers up the motor and turns the Motor Enable Gauge to the ON position. Powers up all high-voltage power from the drive battery.

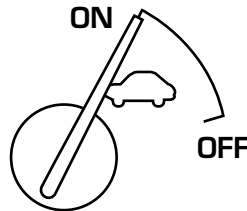
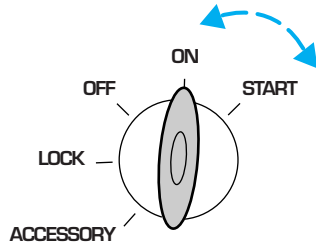

## STARTING THE RANGER ELECTRIC VEHICLE

1. If connected, disconnect the PCS plug from the charge inlet and close the charge inlet access door.

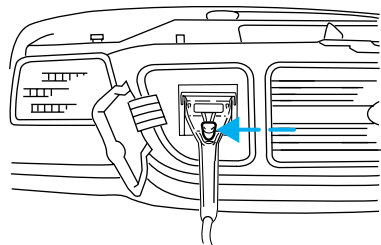

The car will not start until the plug is removed.

## Starting

1. Make sure all vehicle occupants have buckled their safety belts. For more information on safety belts and their proper usage, refer to the seating and safety restraints chapter in the Ranger owner guide.

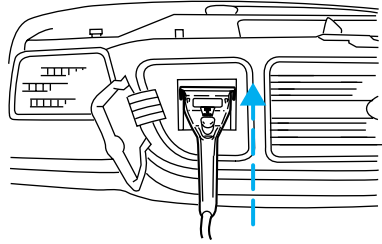

1. Make sure the parking brake is set.

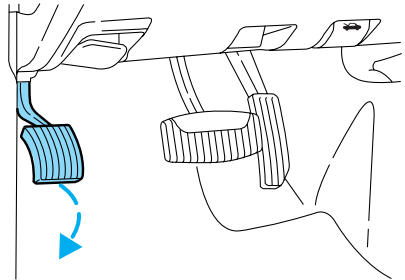

2. Make sure the gearshift lever is in P (Park).



3. Turn the key to the START position and release. The Motor Enabled gauge will point to the ON position, indicating the vehicle is on.

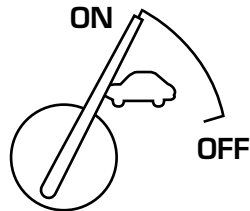

## Starting

4. Check the drive Battery State of Charge gauge to confirm that the drive battery is charged sufficiently for the planned trip.

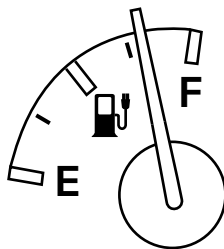

5. Pull the release lever to release the parking brake. The Ranger electric vehicle is now ready to be driven.

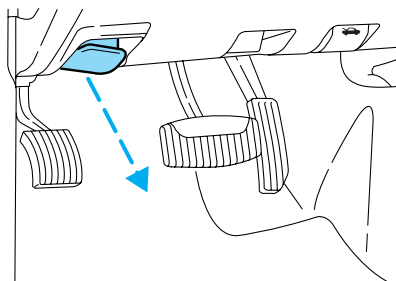



### **REGENERATIVE BRAKING**

Your Ranger Electric Vehicle uses a unique feature known as regenerative braking. This is used to simulate the engine braking of an internal combustion engine and assist the standard brake system while recovering some of the energy of motion back into the battery.

The standard brake system is designed to fully stop the truck if regenerative braking is not available.

Once the accelerator pedal is released, the vehicle automatically decelerates slowly. This deceleration is caused by using the spinning motor as a generator to create electrical current. This recharges the traction battery and slows the vehicle. In effect, once the accelerator pedal is released, the motor changes from an energy user to an energy producer. When the battery is almost fully charged, the amount of regenerative braking is limited to avoid overcharging.

Regenerative braking does not take the place of the standard friction brakes; it only assists them. Regenerative braking has also been designed to interact with the anti-lock brake system (ABS). Regenerative braking is disabled when the ABS is activated or the battery is fully charged.

### **ANTI-LOCK BRAKE SYSTEM (ABS)**

A noise from the hydraulic pump motor and pulsation in the brake pedal may be observed during ABS braking events. Pedal pulsation coupled with noise while braking under panic conditions or on loose gravel or wet snowy roads is normal and indicates proper functioning of the brake system. If the vehicle has continuous vibration or shudder while braking, felt mainly in the steering wheel, the vehicle most likely needs service.

The ABS operates by detecting the onset of wheel lockup during brake applications and compensating for this tendency.

### **ABS warning lamp**

The ABS warning lamp in the instrument cluster illuminates if an ABS fault is detected.



## Driving

An ABS fault will also illuminate the BRAKE warning lamp. The base hydraulic brake system will still be effective. Have your vehicle serviced as soon as possible.



### **Using ABS**

- In an emergency or when maximum efficiency from the ABS is required, apply continuous full force on the brake pedal. The ABS will be activated immediately (thus allowing you to retain full steering control of your vehicle) and (providing there is sufficient space) will enable you to avoid obstacles and bring the vehicle to a controlled stop.
- We recommend that you familiarize yourself with this braking technique. Avoid, however, taking any unnecessary risks.
- Regenerative braking is disabled while ABS is active allowing ABS full control.

### **STEERING**

Your Ranger Electric Vehicle has variable assist power steering. The power steering uses energy from the battery to help steer your vehicle.

If the amount of effort needed to steer your vehicle changes at a constant speed, have the power steering system checked. If the power steering system breaks down (or if the vehicle is turned off), you can steer the vehicle manually, but it takes more effort.

Avoid holding the steering wheel to the extreme right or left for more than five seconds if the vehicle is running.

**When starting the vehicle at extremely cold temperatures (-20°C[-4°F]), a 10-second delay will occur prior to power steering pump start-up. This will result in a delay of power steering assist during initial start-up.**

### **TRANSAXLE OPERATION**

Your vehicle is equipped with a brake shift interlock that prevents shifting of the gearshift lever out of park unless the foot brake is applied. Step on the brake pedal and pull the gearshift lever towards you and downward to move the gearshift lever.



Hold the brake pedal down while you move the gearshift lever from P (Park) to another position. If you do not hold the brake pedal down, your vehicle may move unexpectedly and injure someone.

## P (Park)



Always set the parking brake fully and make sure the gearshift is latched in P (Park). Turn off the ignition whenever you leave your vehicle.



Always come to a complete stop before shifting into P (Park). Make sure the gearshift lever is in P (Park).

## R (Reverse)

With the gearshift lever in R (Reverse), the vehicle will move backward. Always come to a complete stop before shifting into and out of R (Reverse). Regenerative braking is applied in reverse too, at a level similar to the D (Drive) gear. When the drive battery is almost fully charged, the amount of regenerative braking is limited to avoid overcharging.



## N (Neutral)

With the gearshift lever in N (Neutral), the vehicle can be started and is free to roll. Hold the brake pedal down while in this gear to prevent movement.



## D (Drive)

With the gearshift lever in D (Drive), the vehicle will move forward. Top speed is limited to 121 km/h (75 mph). The transaxle operates in forward gear. This selection is recommended for highway operation. Deceleration from regenerative braking is commanded when the driver lifts off on the accelerator pedal or when the brake pedal is pressed. However, when the battery is almost fully charged, the amount of regenerative braking is limited.



# Driving

## E (Economy)

With the gearshift lever in E (Economy), the Ranger operates as in drive, but the effects of



regenerative braking are increased and top speed is limited to 105 km/h (65 mph). This selection is recommended for urban operation when extended driving range is desired. The economy mode is used to maximize the vehicle's range. A stronger deceleration from regenerative braking results from releasing the accelerator pedal. In this regard, it feels similar to low gear on a typical transmission. When the battery is almost fully charged, the amount of regenerative braking is limited.

## Low charge

As the Ranger Electric Vehicle is driven, the Battery State of Charge Gauge indicates the battery's remaining charge like a fuel gauge does on a conventional gasoline-powered vehicle. When the gauge approaches the Empty (E) position, the vehicle should be connected to a PCS before the drive battery is completely drained.

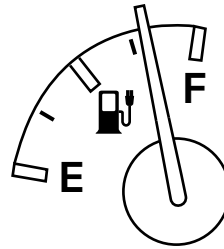

If the Ranger is driven while the Battery State of Charge Gauge reads E, there are two warning lights that illuminate in stages to alert the driver of the vehicle's condition.

This is the order of what the driver will see:

1. At a 10% battery state of charge, the low fuel lamp illuminates.



2. At a 0% battery state of charge, the low fuel lamp flashes. Driving the vehicle below 0% will damage vehicle systems.

3. The power limit lamp illuminates to indicate that the vehicle's performance is being limited to conserve remaining battery power.

**POWER  
LIMIT**

4. The power limit lamp flashes to indicate that the vehicle's performance has been further limited.

Driving the vehicle to complete discharge will damage the battery, resulting in reduced battery life.

### **Driving on snow and ice**

The regenerative braking system interacts with the ABS so if the wheels begin to slide, ABS will activate and regenerative braking will be disabled.

**Vehicle coasting distance will increase when regenerative braking is reduced by ABS activation.**

### **Driving on hill or slope terrain**

When driving down hills, regenerative braking may be used to maintain speed while recovering energy similar to the way engine braking is typically used. E (Economy) gear provides the maximum amount of “engine braking,” like low gear in an automatic transmission.

Once the accelerator pedal is released, the vehicle automatically and slowly decelerates. This deceleration is caused by using the spinning motor as a generator to create electrical current. This recharges the traction battery and slows the vehicle. In effect, once the accelerator pedal is released, the motor changes from an energy user to an energy producer.

When the battery is fully charged, regenerative braking is eliminated to prevent overcharging of the traction batteries. As the traction batteries state of charge begins to diminish with driving usage the amount of regenerative braking is allowed to increase to assist the standard braking system.

Regenerative braking does not take the place of the standard friction brakes; it only assists them. Regenerative braking has also been designed to interact with the anti-lock brake system (ABS). Regenerative braking is disabled when the ABS is activated.

### **TRAILER TOWING**

The Ranger Electric Vehicle should not be used for towing a trailer.

### **TONNEAU COVER**

The cover is intended to improve energy efficiency at freeway speeds. Keep all the cover supports in place when the cover is installed to keep water, snow or ice from accumulating in the center and possibly damaging the cover.

## Driving

### ENERGY TIPS

The Ranger Electric Vehicle has a customer range of approximately 80 kilometers (50 miles) with the standard lead-acid type traction battery or approximately 160 kilometers (100 miles) with the optional nickel metal hydride type traction battery. This range is affected by the use of vehicle accessories, driving habits and weather conditions. To maximize the vehicle's range, follow these steps:

- Use the E (Economy) gear.
- Keep the tires properly inflated to 350 kpa (50 psi).
- Keep payloads as light as possible.
- Avoid frequent full throttle usage.
- Maintain a steady speed while driving.
- Cruise at moderate speeds.
- Select routes that minimize the number of starts and stops encountered.
- Limit the use of max cooling or heating of the vehicle interior.
- Avoid hard acceleration and deceleration.
- Leave the tonneau cover installed on the bed.

**In addition to these steps, connect the Ranger to a Power Control Station (PCS) whenever it is not being driven. This will keep the battery as charged as possible.**

## Roadside emergencies

### INERTIA SHUTOFF SWITCH

If the Power Reset Lamp illuminates, it indicates that the inertia shutoff switch has been activated. If there is no damage to the vehicle, reset the switch to reactivate the high-voltage power systems and restart the vehicle.

The inertia shutoff switch is located by the passenger kick panel. If there is damage to the vehicle, have the vehicle towed to an authorized Ford EV repair facility.

### POWER RESET

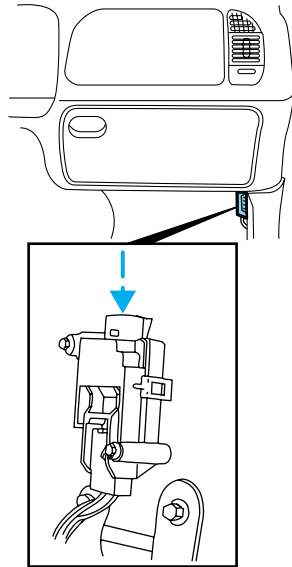

## Roadside emergencies

### PASSENGER COMPARTMENT FUSE PANEL

The fuse panel is on the left-hand side of the instrument panel facing the driver side door. Pull the panel cover outward to access the fuse.

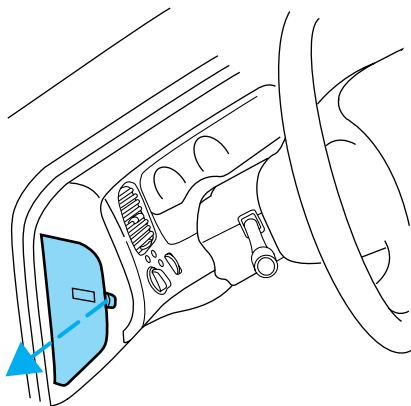

To remove a fuse, use the fuse puller provided on the fuse panel cover.

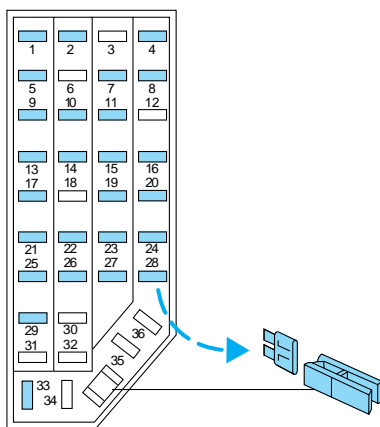



## Roadside emergencies

The passenger compartment fuse panel fuses are coded as follows:

<b>Fuse/relay location</b>	<b>Fuse amp rating</b>	<b>Description</b>
1	10	Instrument cluster
2	7.5	Driver air bag module
3	—	Not used
4	10	Left headlamp
5	7.5	Data link connector (DLC)
6	—	Not used
7	7.5	Exterior lighting
8	10	Right headlamp
9	10	Traction inverter module (TIM)
10	7.5	Generic electronic module (GEM), shift lock actuator
11	7.5	Traction inverter module (TIM)
12	—	Not used
13	10	Brake on/off (BOO) relay, brake on/off (BOO) switch
14	10	ABS
15	7.5	Main light switch, instrument cluster
16	30	Windshield wiper motor, windshield wiper relays
17	10	Cigar lighter
18	—	Not used
19	15	Steering wheel sensor, interface adapter assembly (IAA) module, contactor box, battery controller module (BCM), power steering controller assembly
20	10	Radio, generic electronic module (GEM)
21	15	Turn signal flasher relay
22	15	Turn signal flasher relay, multi-function switch
23	15	Main light switch
24	7.5	Traction inverter module (TIM)

## Roadside emergencies

Fuse/relay location	Fuse amp rating	Description
25	7.5	Generic electronic module (GEM)
26	15	Backup lamps
27	10	Battery saver realy, dimmer module, interior lamps relay, generic electronic module (GEM)
28	7.5	Generic electronic module (GEM)
29	10	Radio
30	—	Not used
31	—	Not used
32	—	Not used
33	15	Highbeam headlamp
34	—	Not used
35	—	Not used
36	—	Not used

### LOW VOLTAGE POWER DISTRIBUTION BOX

The power distribution box is located in the underhood compartment near the auxiliary battery. The power distribution box contains high-current fuses that protect your vehicle's main electrical systems from overloads.

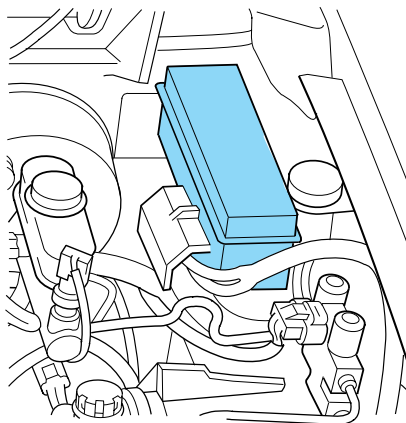

Always disconnect the battery before servicing high current fuses.

## Roadside emergencies



Always replace the cover to the power distribution box before reconnecting the auxiliary battery or refilling fluid reservoirs.

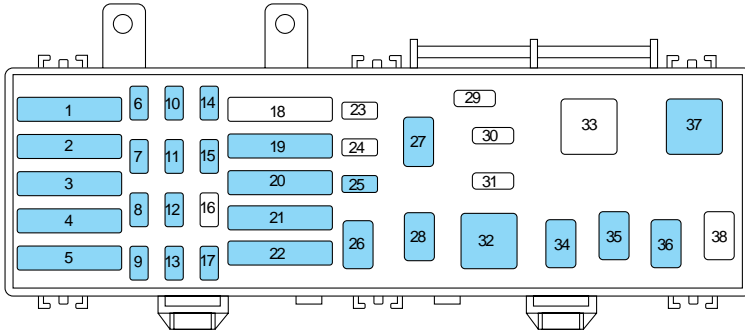

The high-current fuses are coded as follows:

Fuse/relay location	Fuse amp rating	Description
1	MAXI 50	Fan speed relays, cooling fan, interface adapter assembly (IAA) module
2	MAXI 60	ABS
3	MAXI 30	ABS
4	MAXI 40	I/P fuse panel fuses 1,5,9,13,17,21,25 and 29
5	MAXI 50	Ignition switch
6	MINI 10	Interface adapter assembly (IAA) module
7	MINI 10	Contactor box
8	MINI 15	Inertia switch, contactor box
9	MINI 10	Driver air bag module
10	MINI 20	Vacuum relay, vacuum pump
11	MINI 10	Battery controller module (BCM)
12	MINI 10	Horn relay, horn switch, horn
13	MINI 30	Power point
14	MINI 15	Cooling/venting blower relay, battery control module (BCM), cooling/venting blower

## Roadside emergencies

Fuse/relay location	Fuse amp rating	Description
15	MINI 20	I/P fuse panel fuses 23 and 27
16	—	Not used
17	MINI 20	Battery charger
18	—	Not used
19	MAXI 40	Heater blower motor relay, heater blower motor, interface adapter assembly (IAA)
20	MAXI 20	Coolant pump relay, coolant pump
21	MAXI 20	Oil pump relay, transaxle oil pump
22	MAXI 30	Headlamps, multi-function switch
23	—	Not used
24	—	Not used
25	MINI 5	ABS active signal
26	J50	Windshield wiper park relay
27	J50	Brake on/off (BOO) relay
28	J50	Windshield wiper hi/low relay
29	—	Not used
30	—	Not used
31	—	Not used
32	150	Coolant pump relay
33	—	Not used
34	J50	Vacuum pump relay
35	J50	Horn relay
36	J50	Windshield washer pump relay
37	150	Blower motor relay
38	—	Not used

# Roadside emergencies

## CHANGING TIRES

If you get a flat tire while driving, do not apply the brakes heavily. Instead, gradually decrease your speed. Hold the steering wheel firmly and slowly move to a safe place on the side of the road.

### Conventional spare tire information

If you have the optional spare tire, you can use the spare as a regular tire. The spare is identical to the other tires on your vehicle.

Your Ranger EV is equipped with a low rolling resistance high pressure designed tire to extend vehicle range. **Only the same type of tire should be used as a replacement.**

### Location of the spare tire and tools

The spare tire and tools for your vehicle are stowed in the following locations:

Tool	Location
Spare tire	In the pickup bed
Jack, jack handle, wheel nut wrench	Behind the passenger seat

### Removing the spare tire

1. Position or remove the tonneau cover to gain access to the spare tire.
2. Fold the passenger seat back fully forward.
3. Remove the jack handle and lug wrench from the clips under the jack.
4. Remove the jack from the carrier assembly.
5. Assemble the jack handle to the lug wrench as shown in the illustrations.

When connecting the jack handle, assemble the following:

- one handle extension and one typical extension. To assemble, slide parts together. To disconnect, depress button and pull apart.

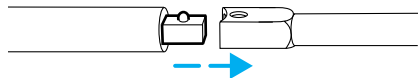

## Roadside emergencies

- one wheel nut wrench. Depress button and slide together.

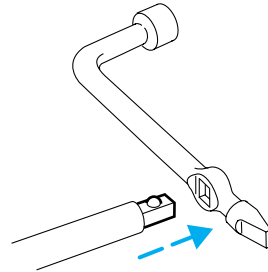

6. Remove the spare tire security lock and cable.

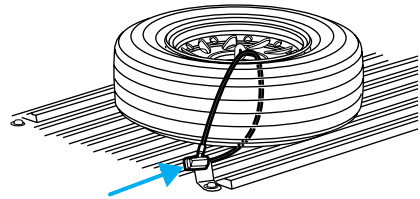

7. Remove the retaining bolt and retainer. If you cannot remove the bolt by hand, remove it using the jack handle.

8. Remove the spare tire.

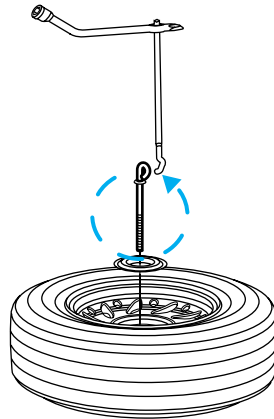

### ***Tire changing procedure***

1. Park on a level surface, activate hazard flashers, and place gearshift lever in P (Park).



## Roadside emergencies

2. Set the parking brake.

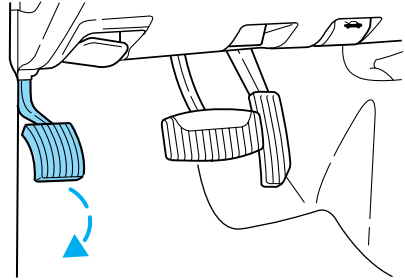

3. Block the diagonally opposite wheel.

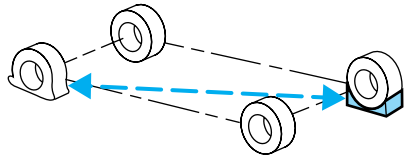

4. Insert tapered end of the lug wrench behind center caps and twist them off.

5. Loosen each wheel lug nut one-half turn counterclockwise, but do not remove them until the wheel is raised off the ground.

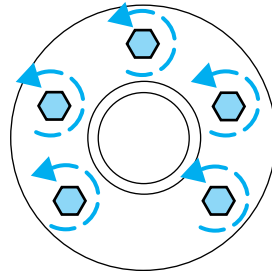

6. Position the jack as shown below and turn the jack handle clockwise until the tire is a maximum of 25 mm (1 in) off the ground.



Never position a jack or hoist underneath the traction battery pack. Doing so may result in damage to your vehicle.

## Roadside emergencies

- Front

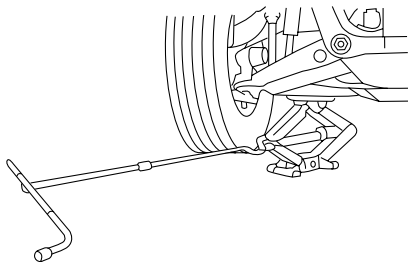

- Rear

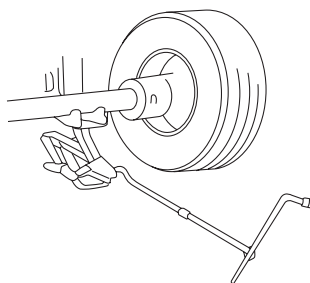

7. Remove the wheel lug nuts with the lug wrench.

8. Replace the flat tire with the spare tire, making sure the valve stem is facing outward. Reinstall the lug nuts until the wheel is snug against the hub. Do not fully tighten the lug nuts until the wheel has been lowered to the ground.

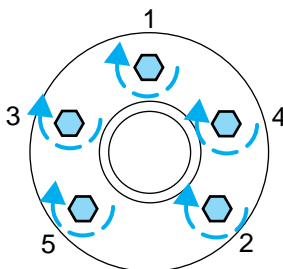

9. Lower the wheel by turning the jack handle counterclockwise.

10. Install the wheel lug nuts with the lug wrench.

11. Secure the flat tire.

12. Install the tonneau cover.

13. Stow the jack and lug wrench. Make sure the jack is snug to the wire clamp by raising the jack until tight.

14. Unblock the wheels.



## Roadside emergencies

### JUMP-STARTING THE AUXILIARY BATTERY

The Ford Electric Ranger can be jump-started like a gasoline-powered Ranger. Note that if the traction battery is dead, jumping the auxiliary battery will not fix the problem. Look at the battery state of charge gauge to verify the traction battery is not discharged. The auxiliary battery might be dead from accessories that were left on accidentally, like the headlights, or dome lamp.

### Preparing your vehicle to be jump started

1. Use only a 12-volt supply to start your vehicle. If you connect your battery to a 24-volt power supply, you can damage your electrical components.
2. Do not disconnect the battery of the disabled vehicle as this could damage the vehicle's electrical system.
3. Park the booster vehicle close to the hood of the disabled vehicle making sure they do not touch. Set the parking brake on both vehicles and stay clear of moving parts.
4. Check all battery terminals and remove any excessive corrosion before you attach the battery cables.

### Connecting the jumper cables

1. Position the vehicles so that they do not touch one another.
2. Switch off the "ignition". Switch off any unnecessary electrical equipment.
3. Connect the positive (+) terminal of the discharged battery (1) to the positive (+) terminal of the booster battery (2).

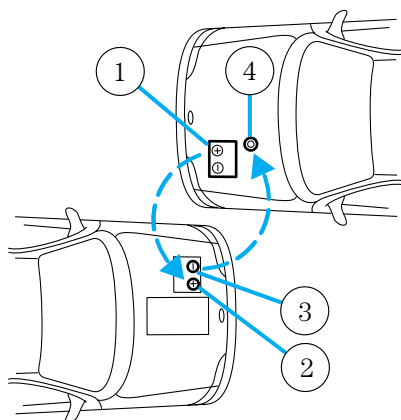

## Roadside emergencies

4. Connect one end of the second lead to the negative (-) terminal of the booster battery (3) and the other end to the module mounting stud (4), not to the negative (-) terminal of the discharged battery.
5. Make sure that the jump leads are clear of moving parts.

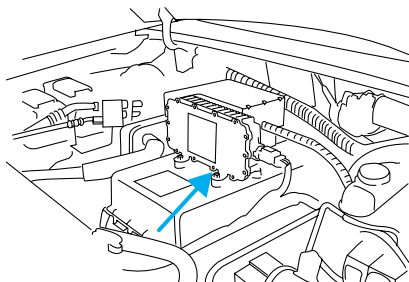

 Do not connect the end of the second cable to the negative (-) terminal of the battery to be jumped. A spark may cause an explosion of the gases that surround the battery.

### Starting your vehicle

1. Turn the “ignition” ON and start the booster vehicle.
2. Turn the “ignition” ON and start the vehicle with the discharged battery.
3. Once the vehicle has been started, allow the vehicle to run for approximately 5 minutes before disconnecting the leads to insure the auxiliary battery is completely charged back up.

 The gases around the battery can explode if exposed to flames, sparks, or lit cigarettes. An explosion could result in injury or vehicle damage.

 Batteries contain sulfuric acid which burns skin, eyes, and clothing.

## Roadside emergencies

### Removing the jumper cables

1. Remove the jumper cables in reverse order. Take the cable off the metallic surface (1) first, followed by the cable on the negative (-) booster battery terminal (2).
2. Remove the cable from the positive (+) terminal of the booster battery (3) and then the discharged battery (4).

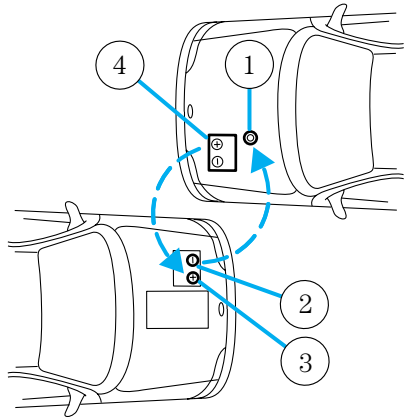

# Roadside emergencies

## WRECKER TOWING

There are three approved towing methods:

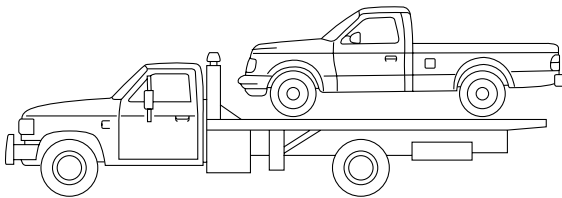
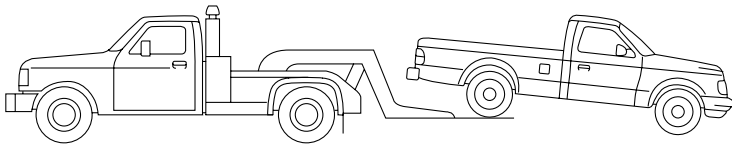
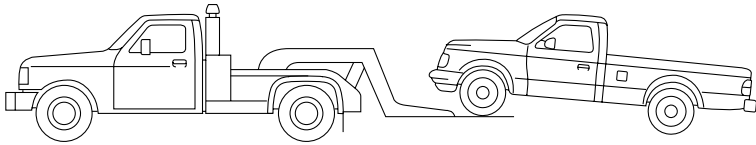

- Front-wheel lift towing (transaxle in Neutral [N]). Do not tow the vehicle more than 80 km (50 miles) when front-wheel lift towing.
- Rear-wheel lift towing.
- Flatbed transporting.

If you need to have your vehicle towed, contact a professional towing service or your roadside assistance center.

Do not tow with slingbelt equipment. Ford Motor Company has not developed or approved a slingbelt towing procedure.

When calling for a tow truck, tell the operator what kind of vehicle you have.

## Maintenance and care

### SERVICE RECOMMENDATIONS

This vehicle should only be serviced by a Ford trained electric vehicle technician.

### Scheduled maintenance chart

Item	Interval									
	1 yr.	2 yrs.	3 yrs.	4 yrs.	5 yrs.	6 yrs.	7 yrs.	8 yrs.	9 yrs.	10 yrs.
Rotate tires 5000 miles MAX	x	x	x	x	x	x	x	x	x	x
Inspect disc brake system, lubricate caliper slides	x	x	x	x	x	x	x	x	x	x
Climate control filter (More frequent changes may be necessary in dusty and dirty conditions)	x	x	x	x	x	x	x	x	x	x
Replace vacuum pump 2A451					x					x
Inspect and lubricate front wheel bearings			x			x			x	
Inspect parking brake system			x			x			x	
Inspect cooling system	x	x	x	x	x	x	x	x	x	x

## Maintenance and care

Item	Interval									
	1 yr.	2 yrs.	3 yrs.	4 yrs.	5 yrs.	6 yrs.	7 yrs.	8 yrs.	9 yrs.	10 yrs.
Replace transaxle fluid*			x			x			x	
Inspect power steering fluid	x	x	x	x	x	x	x	x	x	x
Inspect brake fluid	x	x	x	x	x	x	x	x	x	x

\*Replace transaxle fluid every 3 years or 36,000 miles, whichever comes first.

### HOW TO OPEN THE HOOD

1. Inside the vehicle, pull the hood release handle located under the bottom right of the steering wheel.

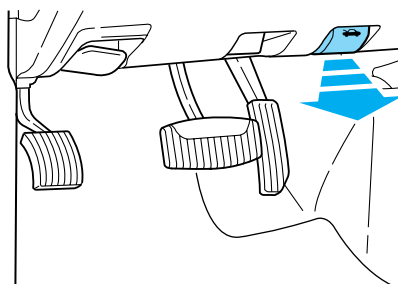

## Maintenance and care

2. Go to the front of the vehicle and release the auxiliary latch that is located under the front center of the hood. Lift the hood and support it with the prop rod.

Identifying components in the underhood compartment:

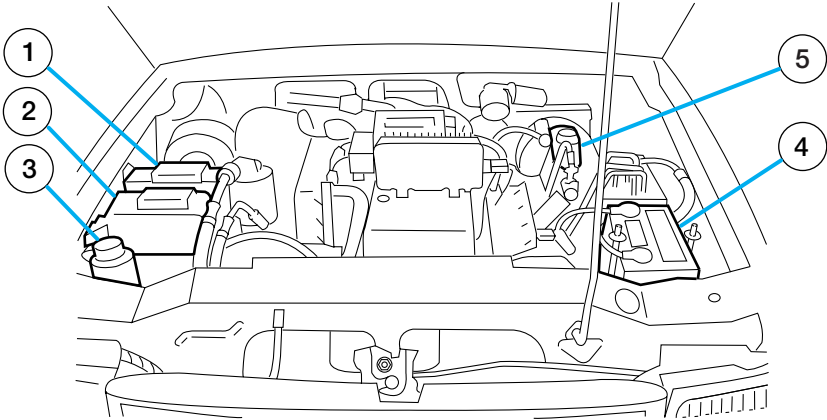

1. Windshield washer fluid reservoir
2. Coolant reservoir
3. Power steering fluid reservoir
4. Auxiliary battery
5. Brake fluid reservoir

The underhood compartment contains many high-voltage components and wiring. Do not attempt to service any of these components. Service must be performed by qualified personnel only.

**The high-voltage wiring is covered in orange convolute for easy identification. Underhood high voltage components have warning labels with one or all of the following icons.**



## Maintenance and care

### WINDSHIELD WASHER FLUID

Check the washer fluid periodically. If the level is low, add enough fluid to fill the reservoir. In very cold weather, do not fill the reservoir all the way.



Do not put engine coolant in the container for the windshield washer fluid.

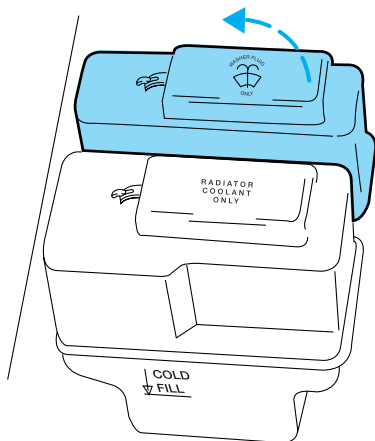

### COOLANT

The EV Ranger is equipped with a cooling system to cool running temperatures of electrical components and the electric drive motor. Check the level of the coolant in the reservoir at least once a month. Be sure to read and understand *Precautions* in this chapter when servicing your vehicle.

If the coolant has not been checked for a long period of time, the coolant reservoir may eventually empty. If this occurs, add coolant to the coolant reservoir.

Automotive fluids are not interchangeable; do not use coolant, antifreeze or windshield washer fluid outside of its specified function and vehicle location.

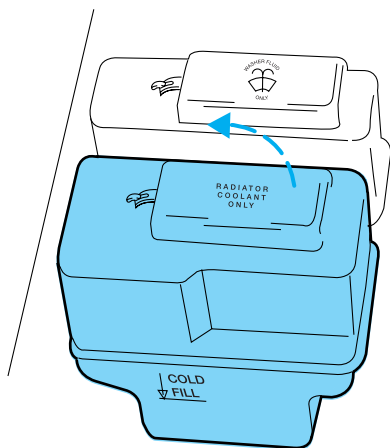



## Maintenance and care

### Adding coolant

If sprayed on the windshield, coolant could make it difficult to see through the windshield.

Add a 50/50 mixture of coolant and water to the coolant reservoir. DO NOT ADD IT DIRECTLY TO THE RADIATOR. Add straight water only in an emergency, and replace it with a 50/50 mixture of coolant and distilled water as soon as possible.

Check the coolant level in the coolant recovery reservoir the next few times you drive the vehicle. If necessary, add enough of a 50/50 mixture of coolant and water to bring the liquid level to the fill line on the reservoir.

Use Ford Extended Life Engine Coolant F6AZ-19544-AA or an equivalent DEX-COOL coolant or a coolant meeting Ford specifications WSS-M97B44-D. Ford Extended Life Engine Coolant is an orange colored silicate-free coolant that does not need to be replaced for the life of your vehicle.

**Do not add conventional, green coolant or recycled coolant to your vehicle if originally equipped with orange coolant.**

The use of an improper coolant may void your warranty of your vehicle's cooling system.

Always dispose of used automotive fluids in a responsible manner. Follow your community's regulations and standards for recycling and disposing of automotive fluids.

### Coolant refill capacity

Have your dealer check the cooling system for leaks if you have to add more than a litre (quart) of coolant per month.

### Severe winter climate

If you drive in extremely cold climates (less than  $-36^{\circ}\text{C}$  [ $-33^{\circ}\text{F}$ ]), it may be necessary to increase the coolant concentration above 50%. Refer to the chart on the coolant container to ensure the coolant concentration in your vehicle is such that the coolant will not freeze at the temperature level in which you drive during the winter months. Never increase the coolant concentration above 60%. Leave a 50/50 mixture of coolant and water in your vehicle year-round in non-extreme climates.

## Maintenance and care

### POWER STEERING FLUID LEVEL

Check the power steering fluid at least twice a year. If adding fluid is necessary, use only MERCON® ATF.

1. Turn the “ignition” ON.
2. Turn the steering wheel left and right to the steering stops several times. Do not keep wheel at steering stops longer than 5 seconds.
3. Turn the “ignition” OFF.
4. Check the fluid level. It should be between the MAX and MIN lines on the reservoir. Do not add fluid above the MAX level.
5. If the fluid is low, add fluid.

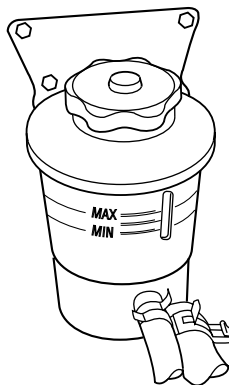

### BRAKE FLUID

#### Checking and adding brake fluid

Brake fluid should be checked and refilled as needed at least once each year:

1. Check the reservoir cap before removal to prevent dirt or water from entering the reservoir.
2. Visually inspect the fluid level.
3. If necessary, add brake fluid until the level reaches MAX. Do not fill above this line.
4. Use only a DOT 3 brake fluid certified to meet Ford specifications. Refer to *Lubricant specifications* in the *Capacities and specifications* chapter.

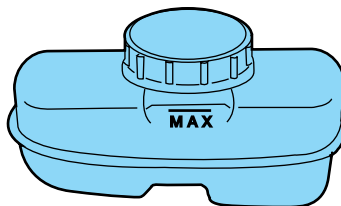

Brake fluid is toxic.

## Maintenance and care



If you use a brake fluid that is not DOT 3, you will cause permanent damage to your brakes.

### AUXILIARY BATTERY

Your vehicle is equipped with a sealed maintenance-free battery.

For longer, trouble-free operation, keep the top of the battery clean and dry. Also, make certain the battery cables are always tightly fastened to the battery terminals.

If you see any corrosion on the battery or terminals, remove the cables from the terminal(s) and clean with a wire brush. You can neutralize the acid solution with a solution of baking soda and water. Reinstall the cables when you are done cleaning them, and apply a small quantity of grease to the top of each terminal to help prevent corrosion.

### TRACTION BATTERY PACK ASSEMBLY

No regular maintenance, other than regular charging is required.

The traction battery pack assembly is located underneath the vehicle between the wheel base and frame rails. The battery pack assembly contains wiring, a fan for ventilation and cooling, and a control system. The standard lead acid battery pack contains 39 eight-volt batteries and optional heater for cold weather climates. The optional nickel metal hydride battery pack contains 25 twelve-volt batteries, and an additional cooling system exhaust fan. The traction battery provides energy to propel the vehicle and also maintains energy for accessory functions. The battery pack assembly is a 2,000-pound unit lead-acid type or 1,300-pound unit nickel metal hydride type.



Never position a jack or hoist underneath the traction battery pack. Doing so may result in damage to your vehicle.



This battery pack should only be serviced by an authorized electric vehicle technician. Improper handling can result in personal injury or death.

## Maintenance and care

### SERVICING YOUR TIRES

#### Checking the tire pressure

- Use an accurate tire pressure gauge.
- Check the tire pressure when tires are cold, after the vehicle has been parked for at least one hour or has been driven less than 5 km (3 miles).
- Check and adjust tire pressure to recommended specifications found on the Safety Compliance Certification Label located on the driver door pillar every 30 days.

**Note: Driving the Electric Ranger with tires below recommended inflation pressure will significantly affect range between charges. Tire pressure will increase/decrease with every 10°F change in outside air temperature, decreasing with temperature decreases.**

#### Tire rotation

Because your vehicle's tires perform different jobs, they often wear differently. To make sure your tires wear evenly and last longer, rotate them every 5,000 miles or six months. If you notice that the tires wear unevenly, have them checked.

- Four-tire rotation.

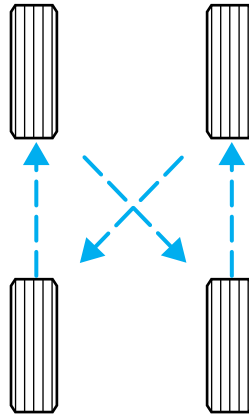

## Maintenance and care

- Five-tire rotation (if equipped)

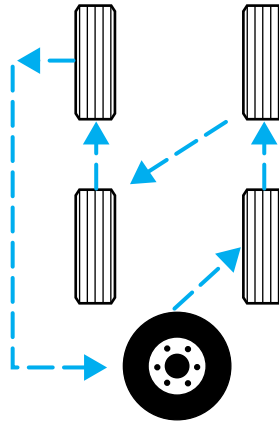

### Replacing the tires

Replace the tires when the wear band is visible through the tire treads.

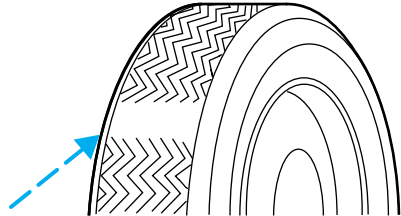

Your Ranger Electric Vehicle is equipped with a low rolling resistance high pressure designed tire to extend vehicle range. **Only the same type of tire should be used as a replacement.**



When replacing full size tires, never mix radial, bias-belted, or bias-type tires. Use only the tire sizes that are listed on the tire pressure decal. Make sure that all tires are the same size, speed rating, and load-carrying capacity. Use only the tire combinations recommended on the decal. If you do not follow these precautions, your vehicle may not drive properly and safely.

## Maintenance and care



Make sure that all replacement tires are of the same size, type, load-carrying capacity and tread design (e.g., “All Terrain”, etc.), as originally offered by Ford.



Failure to follow these precautions may adversely affect the handling of the vehicle and make it easier to lose control and roll over.

### SNOW TIRES AND CHAINS

The use of snow tires and chains is strongly discouraged on the Ranger Electric Vehicle.

## Capacities and specifications

### MOTORCRAFT PART NUMBERS

Component	Part Number
Climate control air filter	F8YZ-19N619-AA
Auxiliary battery	BXE-U1

### REFILL CAPACITIES

Fluid	Ford part name	Vehicle type	Capacity-litres (quarts)
Brake fluid	Ford high performance DOT 3 motor vehicle brake fluid	All	Fill to line in reservoir
Power steering fluid	Motorcraft MERCON® ATF	All	Fill to line in reservoir
Coolant	Ford extended life engine coolant (New for 1999 model year)	All	Fill to line in reservoir
Windshield washer fluid	Ultra-clear windshield	All	Fill to line in reservoir

## Capacities and specifications

### FLUID SPECIFICATIONS

Fluid	Ford part name or equivalent	Ford part number	Ford specification
Brake fluid	High performance DOT 3 motor vehicle brake fluid	C6AZ-19542-AB	WSA-M6C25-A and DOT 3
Power steering fluid	Motorcraft MERCON® ATF	XT-2ODX	MERCON® WSA-M2C195-A
Coolant	Ford extended life engine coolant (New for 1999 model year)	F6AZ-19544-AA	WSS-M97B44-D
Windshield washer fluid	Ultra-clear windshield concentrate	C9AZ-19550-AC or BC	ESR-M17P5-A
Transaxle fluid	Tribolube - L-6 (Pro Gear 21)	F8AZ-19M544-A	

### MOTOR DATA

Motor	Data	
Horsepower	67 kw (90 hp)	
Torque	190 Nm (140 lb/ft)	
Traction battery modules	Standard	Lead-acid type, 312 volts, 39 (8 volts each)
	Optional	Nickel metal hydride, 300 volts, 25 (12 volts each)



### MOBILE RADIO INSTALLATION GUIDELINES

#### General information

Ford Motor Company vehicles are designed and tested for safe operation with properly installed and properly used land mobile/amateur radio communications equipment with up to 100 Watt transmitter power. This resource is provided as a supplement to the radio manufacturer's installation communication equipment in Ford vehicles. Additional sources of information are included in this resource. Special design considerations are incorporated into all Ford vehicle electronic systems to provide immunity to radio frequency signals. To maintain compatibility with vehicle electronic systems, mobile radio and telephone equipment must be properly installed, by trained personnel with experience in this area.

The following guidelines should be observed:

- The antenna cable should be a fully shielded coaxial cable, and kept as short as practical. Avoid routing the antenna cable in parallel with vehicle wiring over long distances.
- Carefully match the antenna and cable to the radio to achieve a low Standing Wave Ratio (SWR) and to avoid RF currents on the antenna cable shield. The procedure to accomplish this is described in the section "Antenna Tuning" below.

Radio transmitters are regulated by the Federal Communications Commission (FCC) in the United States. Compliance with FCC regulations is the responsibility of the manufacturer and/or user of the transmitter equipment and not Ford Motor Company.

## Accessories

### Radio wiring and routing

Power connections should be made directly to the battery and fused as close to the battery as possible.

On the Ranger Electric Vehicle make the connections as follows:

- For the +12V circuit, connect a weatherproof fuse holder to the end of the 10 gauge circuit pigtail that is taped into the harness at the auxiliary battery positive terminal. Route and secure the wire as close as possible to the vehicle body from the battery to the transceiver. Pass the wire from the engine to passengers compartment through a hole in the accelerator's cable hole plug.

Use care when routing this wire to avoid chafing or pinching. Seal the hole to prevent moisture intrusion into the passenger compartment.

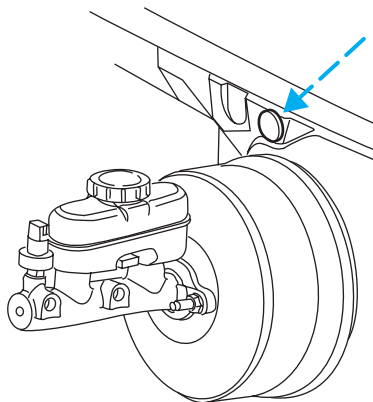
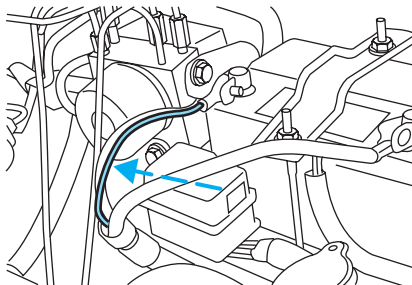

## Accessories

- Connect to the auxiliary battery ground connection using a ring terminal at the ground M6 weldnut behind the LH (driver's) side kick panel.

Maintain as great a distance as possible between mobile radio power leads and the vehicle's wiring. Avoid running power leads in parallel with vehicle wiring over long distances.

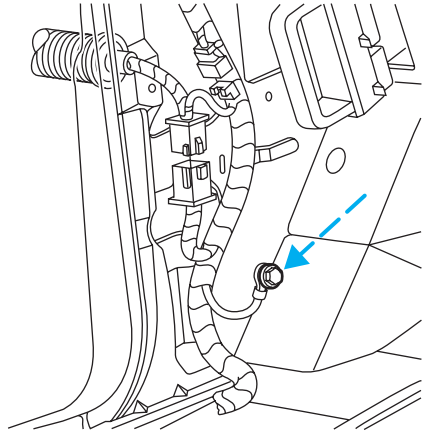

### Transceiver location

A transceiver location should be selected that provides a solid mounting point which does not interfere with the vehicle operator controls and provides adequate ventilation. Do not mount any transceiver, microphones, speakers, or any other item in the deployment path of the airbag system.

Before using screws to mount the transceiver equipment, be sure to check for vehicle wiring under the carpet or behind the instrument panel which could be pinched, cut or otherwise damaged.

### Antenna location and installation

Permanently installed sheet metal mount antennas are preferable over magnetic, glass, or body lip mounts for anything other than low power or temporary installations. Most of these alternate antennas can reflect significant power back at the feed point. This reflected power could then radiate from the feed line inside the passenger compartment and be picked up by the vehicle wiring.

## Accessories

Mount the antenna only on the center of the Ranger Electric Vehicle roof if it is a sheet metal mount antenna. Glass mounted antennas should be mounted as high as possible in the center of the rear window.

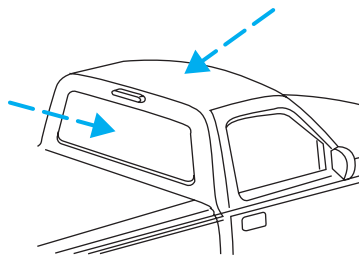

**Antenna Tuning:** It is important that the antenna be tuned properly and reflected power be kept to less than 10% (VSWR less than 2:1). Note: Your installation should be checked periodically for proper SWR and any signs of damage or deterioration to maintain proper operation with your vehicle.

### Antenna Cable Routing

Always use a high quality one piece coaxial cable (at least 95% shield coverage). Connector quality and termination techniques are just as important. The ARRL handbook provides excellent guidelines for terminating coaxial cables.

The antenna cable should be treated in the same way as the control and power cables. Avoid sharp edges and pinches and keep the cable as short as possible. Also, avoid routing the antenna cable in parallel with vehicle wiring over long distances. If it is necessary to cross over wiring, cross at right angles.

### Troubleshooting

Most interaction problems can be eliminated by following these installation guidelines. If vehicle/radio interaction develops following installation, the source of the problem should be identified prior to further operation of the vehicle.

Possible causes of vehicle/radio interaction include:

- Antenna location (move antenna to a position on the vehicle roof)
- Antenna feed line routing (locate as far as possible from vehicle electronics and wiring)
- Inadequate shielding or loose/corroded connectors associated with the antenna feed line
- Mismatched antenna or high SWR
- Power feeds not connected directly to the vehicle battery
- Power feed routing (locate as far as possible away from vehicle electronics and wiring)

If any vehicle/radio interaction problems exist after following these guidelines, contact your radio equipment manufacturer for additional assistance.

### Additional sources of information

The American Radio Relay League, Inc. Technical Information Service  
225 Main St, Newington, CT 06111 Phone: (860)594-0200/Fax:  
(860)594-0259 email: <http://www.arrl.org/tis>

Radio Frequency Interference: How to Find It and Fix It ISBN:  
0-87259-375-4

Giving Two-Way Radio Its Voice (booklet) Champion Spark Plug  
Company Automotive Technical Services Dept. P.O. Box 910,  
Toledo, OH 43661

# Index

Air conditioning .....	9	Jump-starting your vehicle .....	41
Battery .....	19	Lights, warning and indicator .....	3
auxiliary battery .....	51	anti-lock brakes (ABS) .....	5
battery pack heating/cooling		auxiliary battery .....	4
system (lead-acid type) .....	19	brake .....	3
battery pack heating/		charging system .....	3
cooling system (nickel metal		econ mode .....	5
hydride type) .....	20	electrical hazard warning .....	4
equalization .....	20,21	low fuel .....	4
Brakes .....	25	oil pressure .....	3
anti-lock .....	25	power limit .....	4
anti-lock brake system (ABS)		power reset .....	5
warning light .....	25	service indicator .....	3
fluid, checking and adding .....	50	Motorcraft parts .....	55
fluid, refill capacities .....	55	Parts (see Motorcraft parts) .....	55
fluid, specifications .....	56	Power distribution box (see	
Capacities for refilling fluids .....	55	Fuses) .....	34
Charging .....	13	Power steering .....	26
lead-acid traction battery .....	15	fluid, checking and adding .....	50
nickel metal hydride traction		fluid, refill capacity .....	55
battery .....	16	fluid, specifications .....	56
to connect the PCS .....	13	Refill capacities for fluids .....	55
to disconnect the PCS .....	17	Starting your vehicle .....	22
Coolant .....	48	Tires .....	52
checking and adding .....	49	changing .....	37
recovery reservoir .....	48	checking the pressure .....	52
refill capacities .....	49,55	replacing .....	53
specifications .....	56	rotating .....	52
Driving under special		snow tires and chains .....	54
conditions		spare tire .....	37
snow and ice .....	29	Towing	
Engine		trailer towing .....	29
coolant .....	48	Transaxle	
Fuel		automatic operation .....	26
fuel pump shut-off switch .....	31	lubricant specifications .....	56
Fuses .....	32	Warning lights (see Lights) .....	3
Gauges .....	6	Washer fluid	
battery state of charge gauge .....	7	reservoir .....	48
distance to empty gauge .....	7	Windshield washer	
economy gauge .....	7	fluid and wipers	
motor enabled gauge .....	8	reservoir .....	48
Hood .....	46	Wrecker towing .....	44